

D-24 Hose System with 90.700 or 90.705 (Y-700 or Y-705)

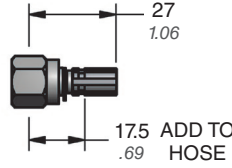

90.508.943 (D-943)
Compact Hose Adapter

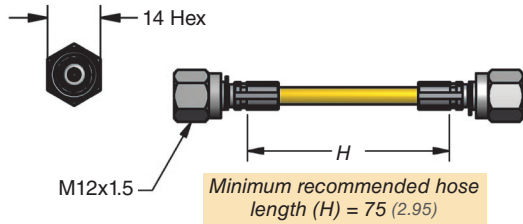
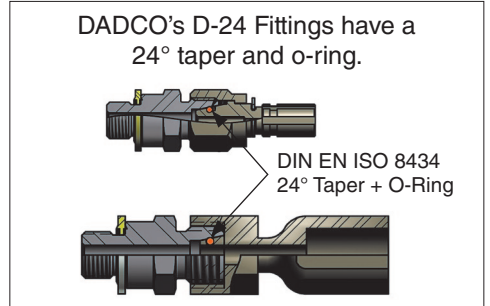

D-24 Hose System with 90.500 (Y-500)

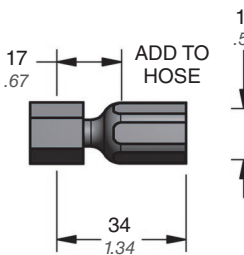
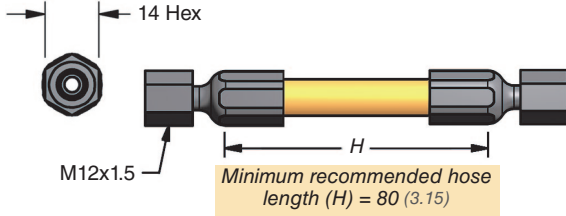

90.508.843 (D-843)
Compact Hose Adapter

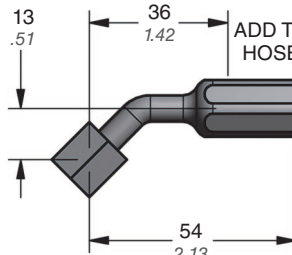

90.508.854 (D-854)
45° Hose Adapter

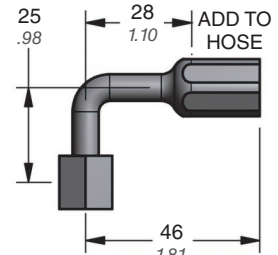

90.508.858 (D-858)
90° Hose Adapter

Fittings

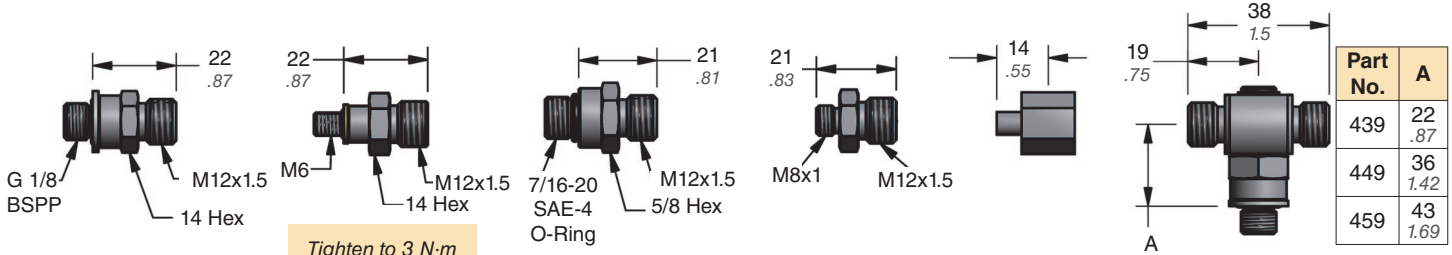

Tighten to 3 N-m

90.508.115 (D-115)
Straight Port Adapter

90.508.116 (D-116)
Straight Port Adapter

90.508.120 (D-120)
Straight Port Adapter

90.508.607 (D-607)
Reducing Union

90.508.112 (D-112)
Tube End Cap

90.508.439 (D-439)
Branch Tee

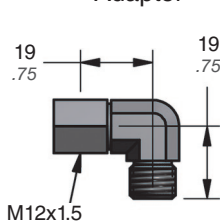

90.508.221 (D-221)
90° Elbow

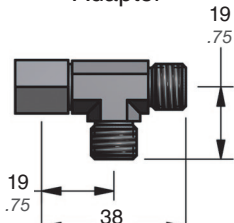

90.508.432 (D-432)
Run Tee

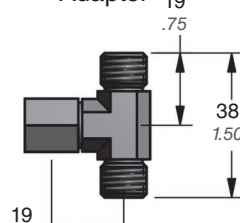

90.508.433 (D-433)
Branch Tee

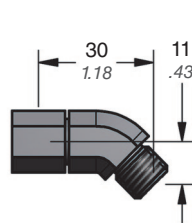

90.508.321 (D-321)
45° Elbow

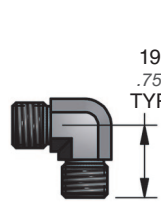

90.508.201 (D-201)
Elbow

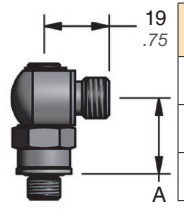

90.508.230 (D-230)
90° Branch Tee

Part No.	A
439	22 .87
449	36 1.42
459	43 1.69

Part No.	A
230	22 .87
240	36 1.42
250	43 1.69

B07133B

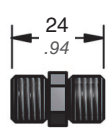

90.508.303 (D-303)
Union

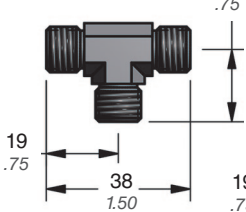

90.508.401 (D-401)
Tee

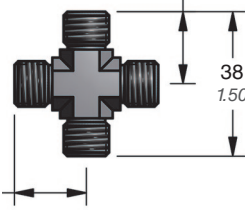

90.508.501 (D-501)
Cross

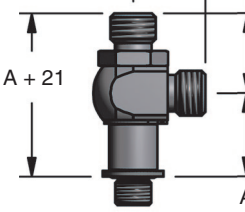

90.508.438 (D-438)
Run Tee

Part No.	A
438	22 .87
448	36 1.42
458	43 1.69

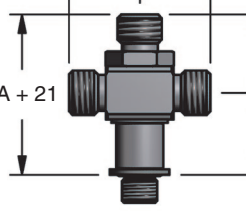

90.508.539 (D-539)
Cross Tee

Part No.	A
539	22 .87
549	36 1.42
559	43 1.69