

Compact Height Nitrogen Gas Springs

90.8N Series

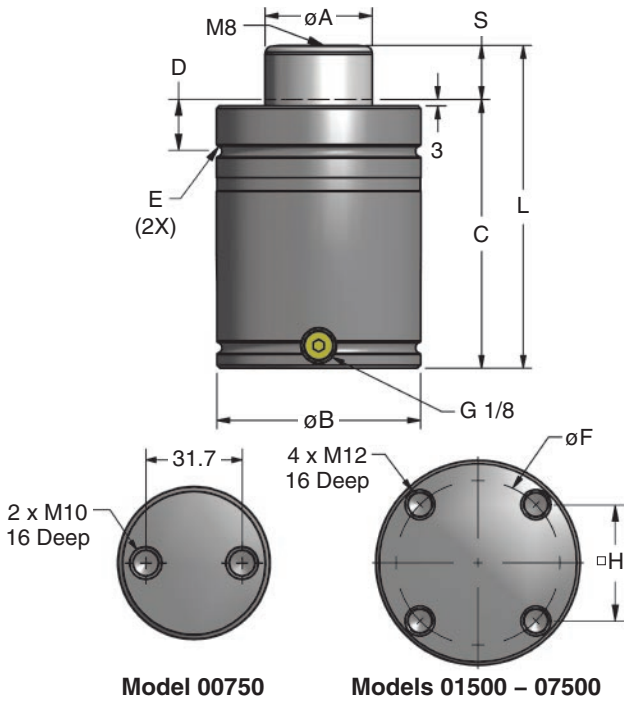

Model: 90.8N.	00750	01500	03000	05000	07500
Contact Force (kN)	7.4	15.3	29.4	49.8	75.4
90% Travel (kN)	11.3	19.9	40.9	77.7	111.7
A	25	36	50	65	80
B	50	75	95	120	150
D	17.5	21	24	25.5	27.5
E	2	2.5	2.5	2.5	2.5
F	–	53.9	76.2	80.8	100
H	–	38.1	53.9	57.1	70.7

Basic Model
(Bottom Radius Groove, Metric Mounting Holes)
 RM = 00750, 03000 – 07500 Models
 RN = 01500 Model Only

Stroke Code	S		90.8N.00750		90.8N.01500		90.8N.03000		90.8N.05000		90.8N.07500	
	in	mm	C	L	C	L	C	L	C	L	C	L
E005	0.50	12.7	107.7	120.4	114.3	127.0	114.3	127.0	114.3	127.0	167.6	180.3
E010	1.00	25.4	120.4	145.8	127.0	152.4	127.0	152.4	127.0	152.4	180.3	205.7
E015	1.50	38.1	133.1	171.2	139.7	177.8	139.7	177.8	139.7	177.8	193.0	231.1
E020	2.00	50.8	145.8	196.6	152.4	203.2	152.4	203.2	152.4	203.2	205.7	256.5
E025	2.50	63.5	158.5	222.0	165.1	228.6	165.1	228.6	165.1	228.6	218.4	281.9
E030	3.00	76.2	171.2	247.4	177.8	254.0	177.8	254.0	177.8	254.0	231.1	307.3
E035	3.50	88.9	183.9	272.8	190.5	279.4	190.5	279.4	190.5	279.4	243.8	332.7
E040	4.00	101.6	196.6	298.2	203.2	304.8	203.2	304.8	203.2	304.8	256.5	358.1
E045	4.50	114.3	209.3	323.6	215.9	330.2	215.9	330.2	215.9	330.2	269.2	383.5
E050	5.00	127.0	222.0	349.0	228.6	355.6	228.6	355.6	228.6	355.6	281.9	408.9
E055	5.50	139.7	234.7	374.4	241.3	381.0	241.3	381.0	241.3	381.0	294.6	434.3
E060	6.00	152.4	247.4	399.8	254.0	406.4	254.0	406.4	254.0	406.4	307.3	459.7
E065	6.50	165.1	260.1	425.2	266.7	431.8	266.7	431.8	266.7	431.8	320.0	485.1
E070	7.00	177.8	272.8	450.6	279.4	457.2	279.4	457.2	279.4	457.2	332.7	510.5
E075	7.50	190.5	285.5	476.0	292.1	482.6	292.1	482.6	292.1	482.6	345.4	535.9
E080	8.00	203.2	298.2	501.4	304.8	508.0	304.8	508.0	304.8	508.0	358.1	561.3
E090	9.00	228.6	–	–	330.2	558.8	330.2	558.8	330.2	558.8	383.5	612.1
E100	10.00	254.0	–	–	355.6	609.6	355.6	609.6	355.6	609.6	408.9	662.9

Model 90.8N.05000	Stroke Code E020	Mount Option RM	Operating System C	Charging Pressure 150
-----------------------------	----------------------------	---------------------------	------------------------------	---------------------------------

Part Number

RM = Basic Model
 (00750, 03000-07500 Models),
 RN = Basic Model
 (01500 Model Only).

Additional mounting options:
 B21, TNF/TNF1, TF/TF1. See
 90.10 Catalog for mount details.

C = Self-contained,
 F = Open Flow
 Fitting.

15-150 bar (1.5-15 Mpa).
 When not specified,
 default is 150 bar.

90.8N Operating and Technical Specifications

Operating Specifications

Charging Medium:	Nitrogen Gas
Charging Pressure Range:	15 – 150 bar (1.5 – 15 MPa)
Operating Temperature:	-6°C – 71°C
Maximum Speed:	.5 m/sec

90.8N Series Repair Kits

Include a fully assembled DADCO cartridge, dust cover, bottle of assembly oil and step-by-step maintenance manual.

Model	Kit Number
90.8N.00750	90.201.00750
90.8N.01500	90.208.01500
90.8N.03000	90.208.03000
90.8N.05000	90.208.05000
90.8N.07500	90.201.07500

CAUTION

DO NOT attempt maintenance on spring until internal pressure is exhausted.

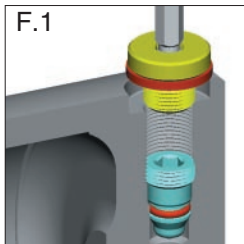

F.1

Self-contained to Linked Operation

- Always wear safety glasses when maintaining gas springs. When exhausting pressure, place the gas spring horizontally with the port up for safety.
- Remove port plug, 90.505.110 (F.1).
- With the cylinder in the horizontal position, depress the valve stem using the appropriate tool (F.2). Cover the port with a cloth to absorb discharge.
- After all of the gas pressure is exhausted, be sure that the piston rod will retract into the tube manually. If not, try depressing the valve again. If still unsuccessful, stop and contact your DADCO Service Representative.
- Remove the valve using the appropriate tool (F.3). Lubricate the threads and o-ring of the port adapter being installed (F.4).
- Install port adapter in open port (F.4). A wide variety of port adapters are available, refer to DADCO's Linking Catalog.

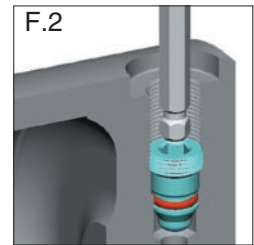

F.2

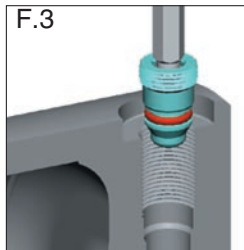

F.3

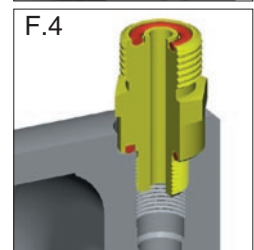

F.4

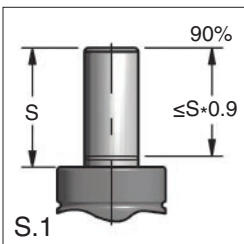

S.1

Provide Stroke Reserve

- DADCO's 90.8N Series Gas Springs will permit travel of the full nominal stroke; however, at least a 10% stroke reserve is recommended to achieve optimal performance and safety (S.1, S.2).
- Overstroking the rod or impacting the top of the gas spring will cause permanent damage.

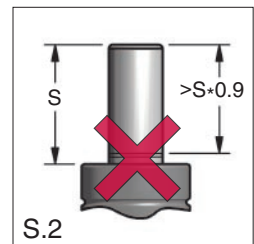

S.2

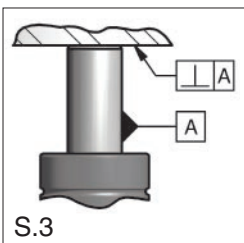

S.3

Avoid Side Loading

- Side loading resulting from press action or die construction causes increased wear on the bearing, seal and piston rod (S.4). Therefore, avoid side loading when possible (S.3).

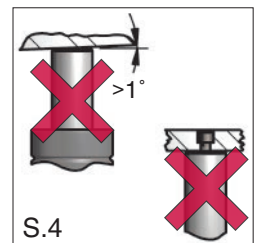

S.4

Rod End Thread

- The end of the piston rod has a construction thread intended for assembly and disassembly only and should never be used to mount or secure the gas spring (S.4). Die vibration and/or misalignment will damage the spring.

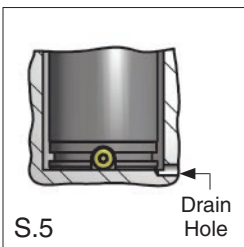

S.5

Protect From Fluids

- Direct contact with certain die lubricants and cleaners should be avoided (S.6). Protect gas springs by providing adequate drainage in gas spring pockets (S.5).

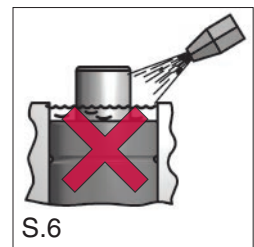

S.6

To see DADCO's full line of mounts, accessories and linked system capabilities, refer to the 90.10 Catalog.

DADCO®

The global leader in nitrogen gas spring technology
 43850 Plymouth Oaks Blvd. • Plymouth, Michigan • 48170 • USA
 734.207.1100 • 800.DADCO.USA • fax 734.207.2222 • www.dadco.net